

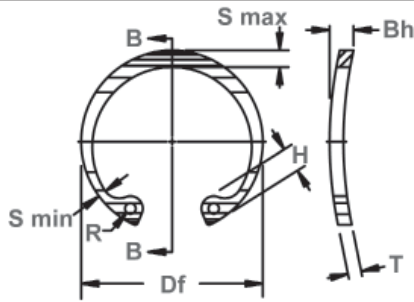

BHO Housing Rings

Axially Assembled, Internal Bowed

Compensating for accumulated tolerances is what a BHO retaining ring is designed to do in a housing/bore. Once snapped into the groove, bowed rings exert a force or "preload" on the retained parts for the range specified.



Free Diameter & Ring Measurements with Section B-B

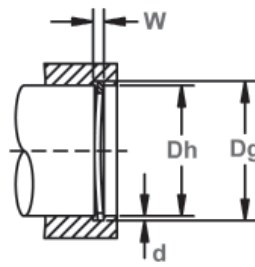

Housing Diameter & Groove Dimensions

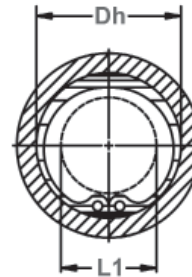

Clearance Diameter Compressed in Housing

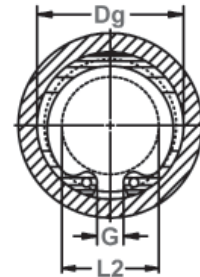

Clearance Diameter & Gap Width Released in Groove

RING NO.	HOUSING DIAMETER			GROOVE SIZE					RING SIZE & WEIGHT				CLEAR.DIA.			THRUST LD. (lbs.)			
				DIAMETER		WIDTH		DEPTH	FREE DIAMETER	THICKNESS***		BOW HEIGHT		Weight Per 1000 Pcs.	Compressed in housing	Released in groove	Sqr. Corner Abutment		
	Dh DEC	Dh FRACT	Dh mm	Dg	Tol.	W	Tol.	d	Df	Tol.	T	Tol.	Bh	Tol.	lbs.	L1	L2	Pr	Pg
BHO-25	.250	1/4	6.4	.268	±.001	.030	+.002	.009	.280		.015		.036		.08	.115	.133	426	190
BHO-31	.312	5/16	7.9	.330	.0015*	.030	-.000	.009	.346		.015		.036		.11	.173	.191	538	240
BHO-37	.375	3/8	9.5	.397		.040		.011	.415		.025		.047		.25	.204	.226	1066	350
BHO-43	.438	7/16	11.1	.461	±.002	.040		.012	.482	±.010	.025		.047	±.006	.37	.23	.254	1238	440
BHO-45	.453	29/64	11.5	.477	.002*	.040		.012	.498		.025		.047		.43	.25	.274	1299	460
BHO-50	.500	1/2	12.7	.530		.055		.015	.548		.035		.063		.70	.26	.29	2010	510
BHO-51	.512	-	13.0	.542	±.002	.055	+.003	.015	.560		.035		.063	±.007	.77	.27	.30	2060	520
BHO-56	.562	9/16	14.3	.596	.004*	.055	-.000	.017	.620		.035		.063		.86	.275	.305	2253	710
BHO-62	.625	5/8	15.9	.665		.055		.020	.694		.035		.063		1.0	.34	.38	2507	1050
BHO-68	.688	11/16	17.5	.732		.055		.022	.763		.035		.063		1.2	.40	.44	2741	1280
BHO-75	.750	3/4	19.0	.796		.055		.023	.831		.035		.063		1.3	.45	.49	3045	1460
BHO-77	.777	-	19.7	.825		.062		.024	.859		.042		.073		1.7	.475	.52	4618	1580
BHO-81	.812	13/16	20.6	.862		.062		.025	.901		.042		.073		1.9	.49	.54	4872	1710
BHO-86	.866	-	22.0	.920		.062		.027	.961		.042		.073		2.0	.54	.59	5177	1980
BHO-87	.875	7/8	22.2	.931		.062		.028	.971		.042		.073		2.1	.545	.60	5227	2080
BHO-90	.901	-	22.9	.959	±.003	.062		.029	1.000	±.015	.042	±.002	.073	±.008	2.2	.565	.62	5430	2200
BHO-93	.938	15/16	23.8	1.000	.004*	.062		.031	1.041		.042		.073		2.4	.61	.67	5684	2450
BHO-100	1.000	1	25.4	1.066		.062		.033	1.111		.042		.073		2.7	.665	.73	6039	2800
BHO-102	1.023	-	26.0	1.091		.062		.034	1.136		.042		.073		2.8	.69	.755	6141	3000
BHO-106	1.062	1-1/16	27.0	1.130		.070		.034	1.180		.050		.085		3.7	.685	.75	7562	3050
BHO-112	1.125	1-1/8	28.6	1.197		.070		.036	1.249		.050		.085		4.0	.745	.815	8019	3400
BHO-118	1.181	-	30.0	1.255		.070		.037	1.319		.050		.085		4.3	.79	.86	8526	3700
BHO-118	1.188	1-3/16	30.2	1.262		.070		.037	1.319		.050		.085		4.3	.80	.87	8526	3700
BHO-125	1.250	1-1/4	31.7	1.330	±.004	.070		.040	1.388	±.025	.050		.085	±.012	4.8	.875	.955	8932	4250
BHO-125	1.259	-	32.0	1.339	.005*	.070		.040	1.388		.050		.085		4.8	.885	.965	8932	4250
BHO-131	1.312	1-5/16	33.3	1.396		.070		.042	1.456		.050		.085		5.0	.93	1.01	9440	4700
BHO-137	1.375	1-3/8	34.9	1.461		.070		.043	1.526		.050		.085		5.1	.99	1.07	9846	5050
BHO-137	1.378	-	35.0	1.464		.070		.043	1.526		.050		.085		5.1	.99	1.07	9846	5050
BHO-143	1.438	1-7/16	36.5	1.528		.070		.045	1.596		.050		.085		5.8	1.06	1.15	10353	5500
BHO-145	1.456	-	37.0	1.548		.070		.046	1.616		.050		.085		6.4	1.08	1.17	10455	5700
BHO-150	1.500	1-1/2	38.1	1.594		.070		.047	1.660		.050		.085		6.5	1.12	1.21	10708	6000
BHO-156	1.562	1-9/16	39.7	1.658		.100		.048	1.734		.062		.115		8.9	1.14	1.23	13906	6350
BHO-156	1.575	-	40.0	1.671	±.005	.100	+.005	.048	1.734	+.035	.062	±.003	.115	±.015	8.9	1.15	1.24	13906	6350
BHO-162	1.625	1-5/8	41.3	1.725	.005*	.100	-.000	.050	1.804	-.025	.062		.115		10.0	1.15	1.25	14413	6900
BHO-175	1.750	1-3/4	44.4	1.858		.100		.054	1.942		.062		.115		10.3	1.26	1.36	15580	8050

*F.I.M. (FULL INDICATOR MOVEMENT)-MAXIMUM ALLOWABLE DEVIATION OF CONCENTRICITY BETWEEN GROOVE AND HOUSING.

† BASED ON HOUSINGS/SHAFTS MADE OF COLD ROLLED STEEL. FOR AN EXPLANATION OF FORMULAS USED TO DERIVE THRUST LOAD AND OTHER PERFORMANCE DATA, CONTACT THE ROTOR CLIP ENGINEERING DEPT.

*** FOR PLATED RINGS, ADD .002" TO THE LISTED MAXIMUM THICKNESS.

HARDNESS RANGES: STAINLESS STEEL RINGS (PH 15-7MO)

RING TYPE	SIZE RANGE	SCALE	ROCKWELL HARDNESS
BHO	25&31	15N	82.5-86
	37-102	30N	63-69.5
	106+	C	44-51



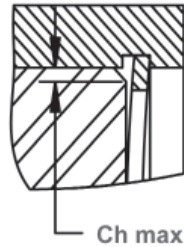
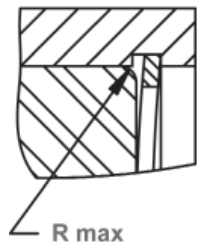

Maximum Corner Radius & Chamfer

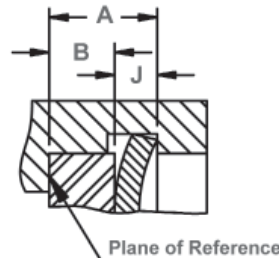

Outer Groove Location
 $A \max = B \min + J \max$
 $A \min = B \max + J \min$

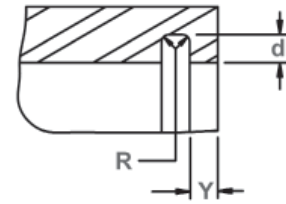

Exploded Groove Profile & Edge Margin (Y)
 Maximum bottom radii (R), .005 for ring sizes -25 thru -100; .010 for ring sizes -102 and over

RING NO.	DISTANCE Outer groove wall to face of retained part		TAKE UP Resilient take up of tolerances of A&B	FORCE Needed to flatten rings	ALLOWABLE CORNER RADII & CHAMFERS		MAX LOAD w/ R max or Ch max (in lbs.)	EDGE MARGIN	LUG HEIGHT	MAXIMUM SECTION		MINIMUM SECTION		HOLE DIAMETER		GAP WIDTH Ring in groove
	J min	J max			J max-J min	lbs.				R max	Ch max	P'r	Y	H	Tol.	
BHO-25	.020	.028	.008	20	.011	.0085	190	.027	.065	±.003	.025	±.002	.015	±.002	.031	.047
BHO-31	.020	.028			.016	.013		190	.027		.066	.033	.018	.031		
BHO-37	.030	.038			.023	.018		530	.033		.082	.040	.028	.041		
BHO-43	.030	.038			.027	.021		530	.036		.098	.049	.029	.041		
BHO-45	.030	.038			.027	.021		530	.036		.098	.050	.030	.047		
BHO-50	.042	.053			.027	.021		1100	.045		.114	.053	.035	.047		
BHO-51	.042	.053			.027	.021		1100	.045		.114	.053	.035	.047		
BHO-56	.042	.053			.027	.021		1100	.051		.132	.053	.035	.047		
BHO-62	.042	.053			.027	.021		1100	.060		.132	.060	.035	.062	+ .010	
BHO-68	.042	.053			.027	.021		1100	.066		.132	.063	.036	.062	- .002	
BHO-75	.042	.053	.032	.025	1100	.069	.142	.070	.040	.062	.015					
BHO-77	.049	.060	.035	.028	1650	.072	.146	.074	.044	.062						
BHO-81	.049	.060	.035	.028	1650	.075	.155	.077	.044	.062						
BHO-86	.049	.060	.035	.028	1650	.081	.155	.081	.045	.062						
BHO-87	.049	.060	.035	.028	1650	.084	.155	.084	.045	.062						
BHO-90	.049	.060	.038	.030	1650	.087	.155	.087	.047	.062						
BHO-93	.049	.060	.038	.030	1650	.093	.155	.091	.050	.062						
BHO-100	.049	.060	.042	.034	1650	.099	.155	.104	.052	.062						
BHO-102	.049	.060	.042	.034	1650	.102	.155	.106	.054	.062						
BHO-106	.057	.068	.044	.035	2400	.102	.180	.110	.055	.078						
BHO-112	.057	.068	.047	.036	2400	.108	.180	.116	.057	.078	.015					
BHO-118	.057	.068	.047	.036	2400	.111	.180	.120	.058	.078						
BHO-118	.057	.068	.047	.036	2400	.111	.180	.120	.058	.078						
BHO-125	.057	.068	.048	.038	2400	.120	.180	.124	.062	.078						
BHO-125	.057	.068	.048	.038	2400	.120	.180	.124	.062	.078						
BHO-131	.057	.068	.048	.038	2400	.126	.180	.130	.062	.078						
BHO-137	.057	.068	.048	.038	2400	.129	.180	.130	.063	.078						
BHO-137	.057	.068	.048	.038	2400	.129	.180	.130	.063	.078						
BHO-143	.057	.068	.048	.038	2400	.135	.180	.133	.065	.078						
BHO-145	.057	.068	.048	.038	2400	.138	.180	.133	.065	.078						
BHO-150	.057	.068	.048	.038	2400	.141	.180	.133	.066	.078	.015					
BHO-156	.075	.095	.064	.050	3900	.144	.202	.157	.078	.078						
BHO-156	.075	.095	.064	.050	3900	.144	.202	.157	.078	.078						
BHO-162	.075	.095	.064	.050	3900	.150	.227	.164	.082	.078						
BHO-175	.075	.095	.064	.050	3900	.162	.234	.171	.083	.078						

LARGER SIZES MAY BE AVAILABLE UPON REQUEST.

HARDNESS RANGES: CARBON STEEL RINGS (SAE 1060-1090)

RING TYPE	SIZE RANGE	SCALE	ROCKWELL HARDNESS
BHO	25&31	15N	86-88
	37-51	30N	69.5-73
	56-77	30N	67.5-72
	81-102	30N	66-71
	106+	C	47-52

HARDNESS RANGES: BERYLLIUM COPPER RINGS

RING TYPE	SIZE RANGE	SCALE	ROCKWELL HARDNESS
BHO	25&31	15N	77-82
	37-102	30N	54-62
	106+	C	34-43

